

SHINDAIWA OWNER'S/OPERATOR'S MANUAL

T282 TRIMMER

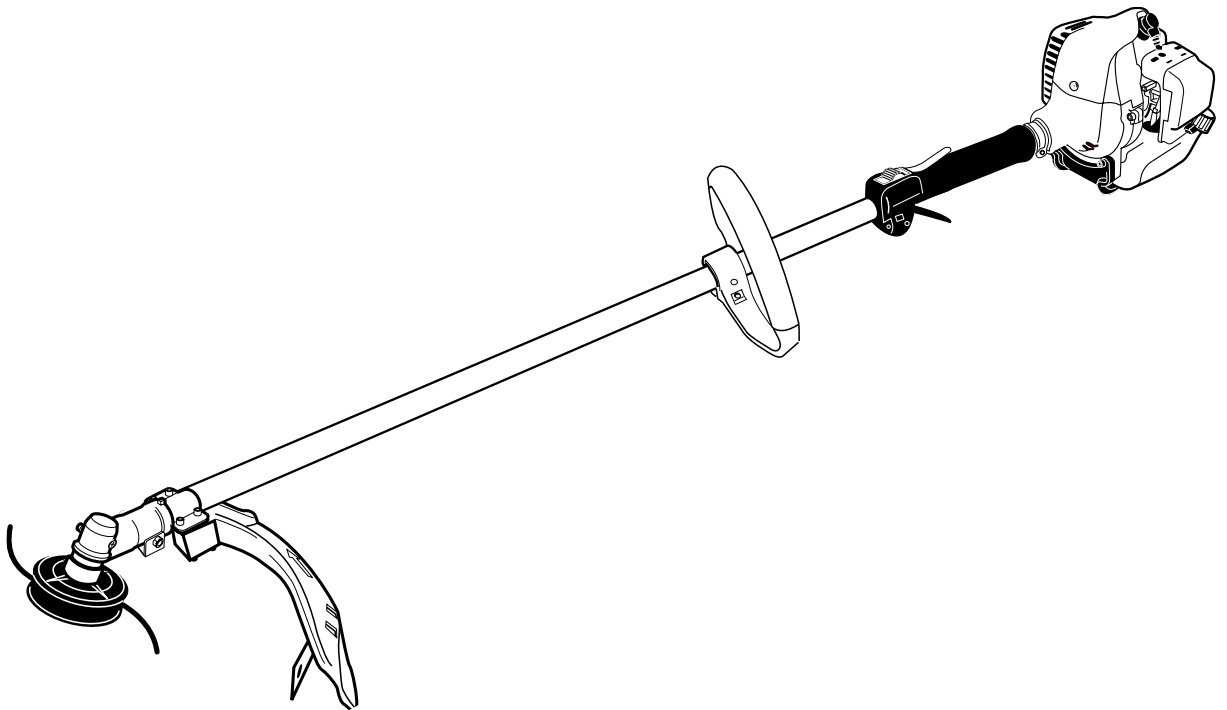

WARNING!

Minimize the risk of injury to yourself and others! Read this manual and familiarize yourself with the contents. Always wear eye and hearing protection when operating this unit.

X7502824801
04/12

shindaiwa[®]

Introduction

The Shindaiwa 282 series is designed and built to deliver superior performance and reliability without compromise to quality, comfort, safety or durability.

Shindaiwa engines represent the leading edge of high-performance engine technology, delivering exceptionally high power with remarkably low displacement and weight. As an owner/operator, you'll soon discover for yourself why Shindaiwa is simply in a class by itself!

IMPORTANT!

The information contained in these instructions describes units available at the time of publication.

Shindaiwa reserves the right to make changes to products without prior notice, and without obligation to make alterations to units previously manufactured.



WARNING!

The engine exhaust from this product contains chemicals known to the State of California to cause cancer, birth defects or other reproductive harm.

Contents

	PAGE		PAGE
Safety	3	Stopping the Engine	12
Product Description	6	Checking Unit Condition	13
Specifications	6	Operation	13
Emission Control	7	Maintenance	14
Assembly	7	Long Term Storage	19
Mixing fuel	9	Troubleshooting Guide	20
Filling the fuel tank.....	10	Warranty Statement.....	23
Starting the Engine	11		

IMPORTANT!

The procedures described in this manual are intended to help you get the most from your unit as well as to protect you and others from harm. These procedures are guidelines for safe operation under most conditions, and are not intended to replace any safety rules and/or laws that may be in force in your area. If you have questions regarding your power tool, or if you do not understand something in this manual, your Shindaiwa dealer will be glad to assist you. You may also contact Shindaiwa at the address printed on the back of this Manual.

Attention Statements

Throughout this manual are special "attention statements".



DANGER!

A statement preceded by the triangular attention symbol and the word "DANGER" contains information that should be acted upon to prevent serious injury or death.



WARNING!

A statement preceded by the triangular attention symbol and the word "WARNING" contains information that should be acted upon to prevent serious bodily injury.

IMPORTANT!

A statement preceded by the word "IMPORTANT" is one that possesses special significance.

CAUTION!

A statement preceded by the word "CAUTION" contains information that should be acted upon to prevent mechanical damage.

NOTE:

A statement preceded by the word "NOTE" contains information that is handy to know and may make your job easier.

Warning and Operational Labels



Read and follow this operator's manual. Failure to do so could result in serious injury..



Beware of thrown or ricocheted objects



Always wear a harness when operating this unit with a blade. A harness is also recommended when using trimmer line.



Wear eye and hearing protection at all times during operation of this unit. Wear head protection where there is a risk of falling objects.



DO NOT use this unit with a blade!



If unit is used as a brushcutter, beware of blade thrust. A jammed blade can cause the unit to jerk suddenly and may cause the operator to lose control of the unit.



Make sure no one is within 15 M / 50 feet of an operating machine.

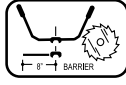

DO NOT operate this unit with a blade unless the unit is equipped with a Shindawia-approved handlebar or barrier.



WARNING: Surface can be hot. Always wear gloves when handling this unit.

Safety

Work Safely

Trimmers and brushcutters operate at very high speeds and can do serious damage or injury if they are misused or abused. *Never allow a person without training or instruction to operate this unit!*



WARNING! Never make unauthorized attachment installations.

Stay Alert

You must be physically and mentally fit to operate this unit safely.



WARNING! Never operate power equipment of any kind if you are tired or if you are under the influence of alcohol, drugs, medication or any other substance that could affect your ability or judgement.





WARNING!
Use Good Judgment

<p>ALWAYS inspect unit before each use. Replace any damaged parts.</p> <p>NEVER run the engine when transporting the unit.</p> <p>NEVER run the engine indoors! Make sure there is always good ventilation. Fumes from engine exhaust can cause serious injury or death.</p> <p>ALWAYS stop the unit immediately if it suddenly begins to vibrate or shake. Inspect for broken, missing or improperly installed parts or attachments.</p>	<p>NEVER extend trimming line beyond the length specified for your unit.</p> <p>ALWAYS keep the unit as clean as practical. Keep it free of loose vegetation, mud, etc.</p> <p>ALWAYS hold the unit firmly with both hands when cutting or trimming, and maintain control at all times.</p> <p>ALWAYS use the proper cutting tool for the job.</p>	<p>ALWAYS keep the handles clean.</p> <p>ALWAYS disconnect the spark plug wire before performing any maintenance work.</p> <p>ALWAYS, if a saw blade should bind fast in a cut, shut off the engine immediately. Push the branch or tree to ease the bind and free the blade.</p>
---	--	--



WARNING! The ignition components of this machine generate an electromagnetic field during operation which may interfere with some pacemakers. To reduce the risk of serious or fatal injury, persons with pacemakers should consult with their physician and the pacemaker manufacturer before operating this machine. In the absence of such information, ECHO does not recommend the use of ECHO products by anyone who has a pacemaker.

Safety Labels

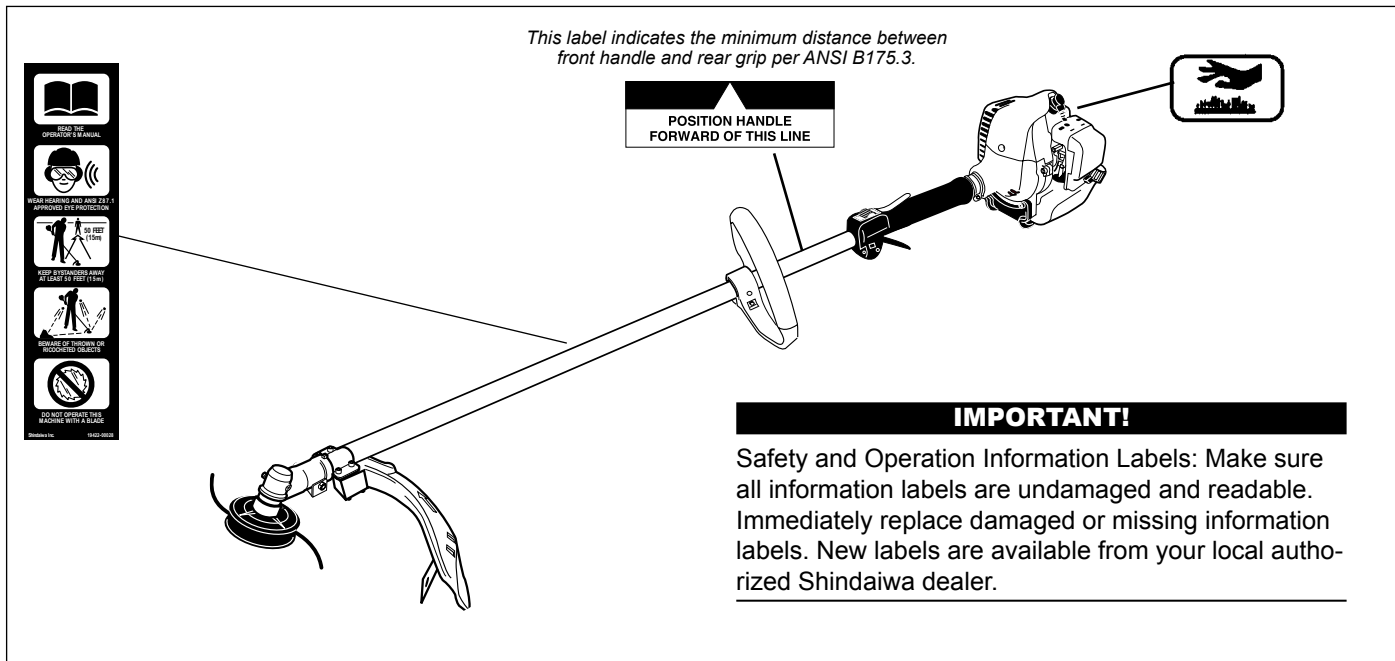

The Properly Equipped Operator

Wear hearing protection devices and a broad-brimmed hat or helmet. A helmet is required when using a blade-equipped brushcutter to clear small trees.

Prolonged exposure to excessive noise is fatiguing and could lead to impaired hearing.

Wear close-fitting clothing to protect legs and arms. Gloves offer added protection and are strongly recommended. Do not wear clothing or jewelry that could get caught in machinery or underbrush. Secure long hair so that it is above shoulder level. NEVER wear shorts!

Long-term exposure to vibration can damage your hands.

Keep a proper footing and do not overreach. Maintain your balance at all times during operation.

Wear appropriate footwear (non-skid boots or shoes): do not wear open-toed shoes or sandals. Never work barefooted!



Always wear eye protection such as goggles or safety glasses to shield against thrown objects.

Always wear a harness when operating the unit. It adds comfort and helps ensure safety by limiting movement fore and aft. When the harness is adjusted properly, the unit should balance with the cutting attachment parallel to the ground.

Always operate with both hands firmly gripping the unit.

When operating with a blade, make sure the handle is positioned to provide you with maximum protection from contacting the blade. Always make sure the handlebar is installed in accordance with the manufacturers instructions.

Always make sure the appropriate cutting attachment shield is correctly installed and in good condition. Do not operate the unit if the cutting attachment shield is missing, loose, or broken.

Keep away from the rotating trimmer line or blade at all times, and never lift a moving attachment above waist-high.

Be Aware of the Working Environment

Avoid long-term operation in very hot or very cold weather.

Be extremely careful of slippery terrain, especially during rainy weather.

Be constantly alert for objects and debris that could be thrown either from the rotating cutting attachment or bounced from a hard surface.

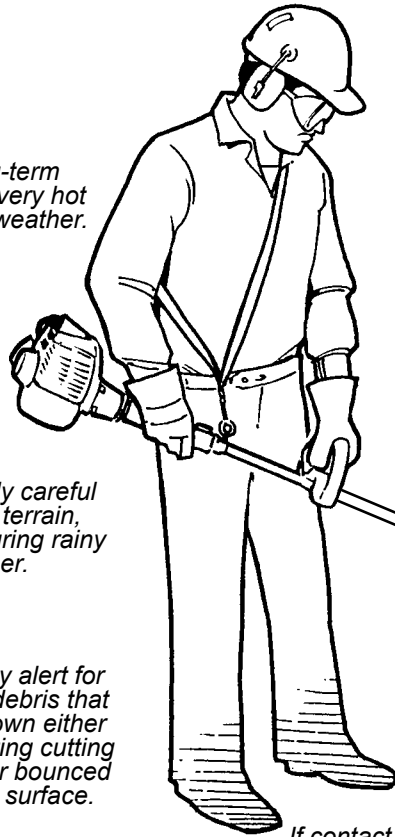

Make sure bystanders or observers outside the 15 meter (50 feet) "danger zone" wear eye protection.

15 METERS (50 FEET)

Always make sure the appropriate cutting attachment shield is correctly installed.

If contact is made with a hard object, stop the engine and inspect the cutting attachment for damage.

Reduce the risk of bystanders being struck by flying debris. Make sure no one is within 15 meters (50 feet)— that's about 16 paces of an operating attachment. Stop immediately if a child, pet, or person comes within a 15 meter (50 feet) radius. Outside this radius, there is still a risk of injury from thrown objects.

Do not operate the unit if the cutting attachment shield is missing, loose, or broken.

Beware of a coasting blade when brushcutting or edging. A coasting blade can injure while it continues to spin after the throttle trigger is released or after the engine is stopped.

ALWAYS clear your work area of trash or hidden debris that could be thrown back at you or toward a bystander. When operating in rocky terrain or near electric wires or fences, use extreme caution to avoid contacting such items with the cutting attachment.

Product Description



WARNING!

Do not make unauthorized modifications or alterations to any of these units or their components.

Using the illustration as a guide, familiarize yourself with your machine and its various components. Understanding your machine helps ensure top performance, long service life and safer operation.

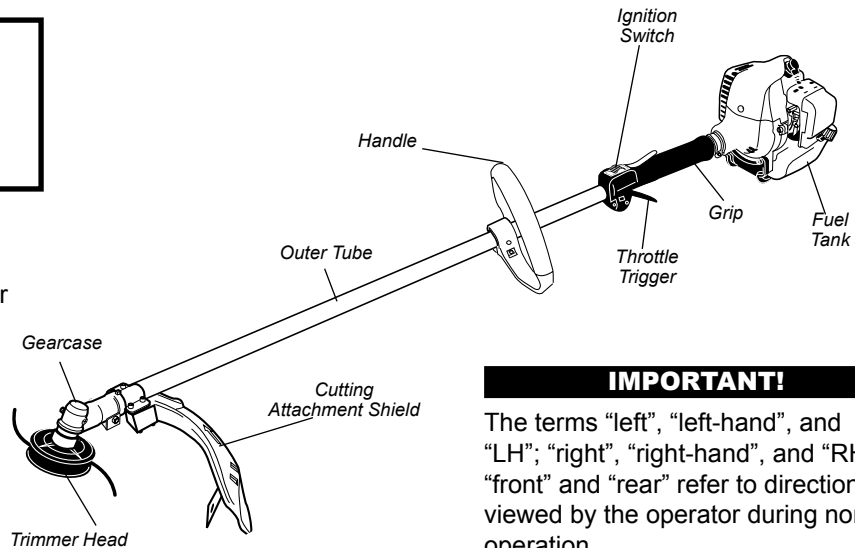

IMPORTANT!

The terms “left”, “left-hand”, and “LH”; “right”, “right-hand”, and “RH”; “front” and “rear” refer to directions as viewed by the operator during normal operation.

Specifications

Model	T282
Engine Type	Air cooled, two stroke, single cylinder gasoline engine
Dry Weight (Without guard and strap)	6.6 kg / 14.7 lb
Dimensions	1775 x 314 x 345 mm / 69.9 x 12.4 x 13.6 in.
Bore x Stroke	1.38 x 1.18 in./ 35 x 30 mm
Displacement	28.9 cc/1.7 cu. in.
Fuel/Oil Ratio	50:1 with *ISO-L-EGD or JASO FD class engine oil
Fuel Tank Capacity	750 ml/25.4 oz..
Carburetor Type	Diaphragm-type carburetor
Ignition	One-piece electronic, transistor-controlled
Spark Plug	BPMR6A
	Spark Plug Gap
	0.6 mm (0.024 in)
	Torque
	16.7 - 18.6 N·m (148-165 in • lbf)
Air Cleaner Type	Non-reversible foam filter element
Starting Method	Recoil
Stopping Method	Slide switch
Transmission Type	Automatic, centrifugal clutch w/bevel gear
Engine Idle Speed	3,000 RPM
Clutch Engagement Speed	3,800 RPM
Wide Open Throttle Speed (W.O.T.)	9,600 RPM

*Specifications are subject to change without notice.

Emission Control (Exhaust & Evaporative)

EPA 2010 and Later and/or C.A.R.B. TIER III

The emission control system for the engine is EM (engine modification) and, if the second to last character of the Engine Family on the Emission Control Information label (sample below) is “C”, “K”, or “T”, the emission control system is EM and TWC (3-way catalyst). The fuel tank/fuel line emission control system is EVAP (evaporative emissions). Evaporative emissions for California models may only be applicable to fuel tanks.

EMISSION CONTROL INFORMATION

ENGINE FAMILY: CEHXS.0214KL DISPLACEMENT: 21.2cc
EMISSION COMPLIANCE PERIOD: 300Hours
THIS ENGINE MEETS 2012 U.S. EPA EXH/EVP
EMISSION REGULATIONS. REFER TO OWNER'S MANUAL FOR
MAINTENANCE SPECIFICATIONS AND ADJUSTMENTS.

YAMABIKO CORP.



EMISSION CONTROL INFORMATION

ENGINE FAMILY: CEHXS.0214KL DISPLACEMENT: 21.2cc
EMISSION COMPLIANCE PERIOD: 300Hours
THIS ENGINE MEETS 2012 U.S. EPA EXH/EVP & CALIFORNIA
EXH/EVP EMISSION REGULATIONS FOR S.O.R.E. REFER TO OWNER'S
MANUAL FOR MAINTENANCE SPECIFICATIONS AND ADJUSTMENTS.

YAMABIKO CORP.



An Emission Control Label is located on the unit. (This is an EXAMPLE ONLY; information on label varies by engine FAMILY).

PRODUCT EMISSION DURABILITY (EMISSION COMPLIANCE PERIOD)

The 300 hour emission compliance period is the time span selected by the manufacturer certifying the engine emissions output meets applicable emissions regulations, provided that approved maintenance procedures are followed as listed in the Maintenance Section of this manual.

Assembly

This unit comes fully assembled with the exception of the cutting attachment shield and cutting attachment.

Prior to Assembly

Before assembling, make sure you have all the components required for a complete unit and inspect unit and components for any damage.

- Engine and shaft assembly
- Cutting attachment shield
- Cutting attachment
- Owner's/operator's manual
- Assembly Tool (s)

Front handle installation

NOTE:

Label shows minimum spacing for front handle location.

1. Position front handle for comfortable operation and secure screw.

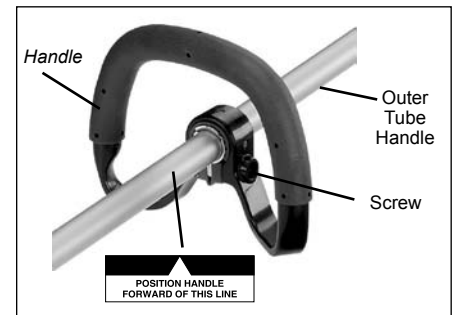

Cutting Attachment Shield

1. Insert the cutting attachment shield between the outer tube and the cutting attachment mounting plate.

NOTE:

It may be necessary to loosen the retaining nut and clamp screw to adjust cutting attachment shield mounting plate.

2. Fit the two shims and the bracket over the outer tube and loosely install the four socket-head screws.
3. Tighten the four socket-head cap screws to secure the cutting attachment shield.

CAUTION!

Make sure the clamp screw and retaining nut are securely tightened before tightening the four socket-head cap screws.

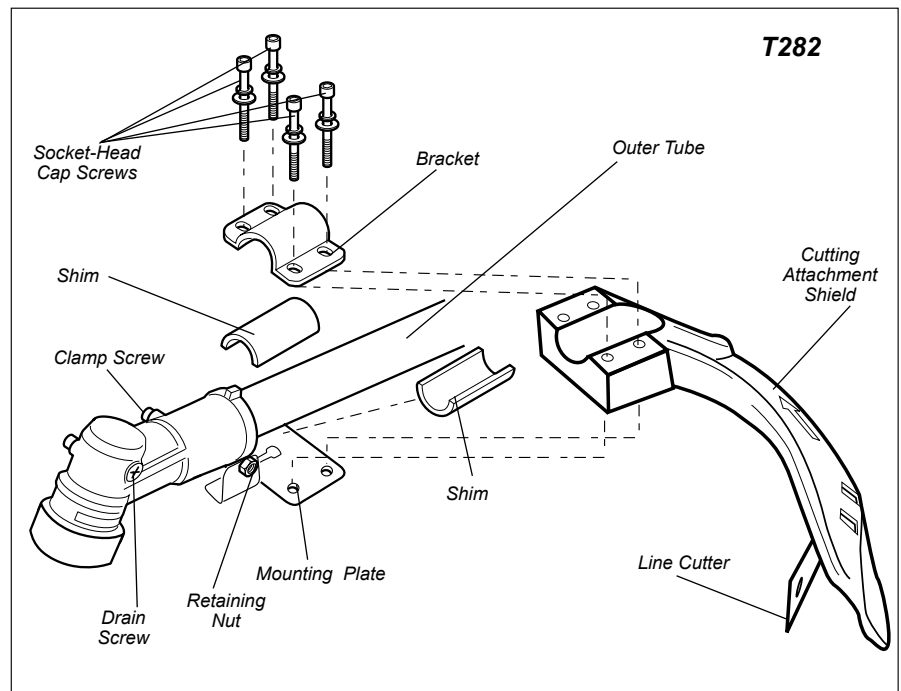

WARNING!

NEVER operate the unit without the cutting attachment shield installed and tightly secured!

Adjust Throttle Lever Free Play

The throttle lever free play should be approximately 4-6 mm. Make sure that the throttle lever operates smoothly without binding. If it becomes necessary to adjust the lever free play, follow the procedures and illustrations that follow.

1. Loosen the air cleaner cover knob and remove the air cleaner cover.
2. Loosen the lock nut on the cable adjuster.
3. Turn the cable adjuster in or out as required to obtain proper free play.
4. Tighten the locknut.
5. Reinstall the air cleaner cover.

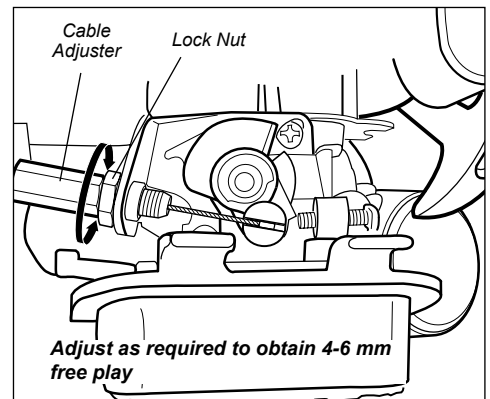
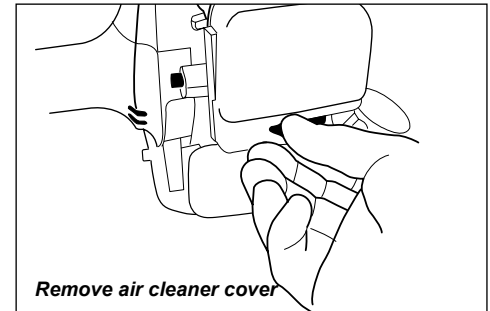
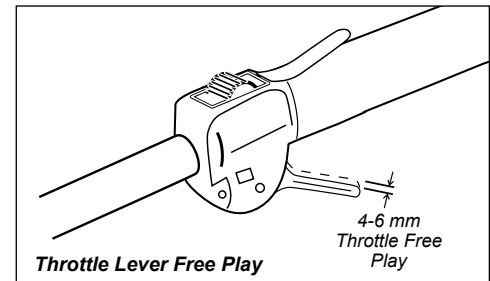

Install trimmer head

1. Turn the trimmer over so that the gear case output shaft faces UP.
2. Remove and discard the black plastic protective cap from the output shaft.
3. Rotate the holder until the hole in the holder aligns with the notch on the gear case. Use the long end of the hex wrench to lock the holder and output shaft.
4. While holding the hex wrench, thread the trimmer head onto the output shaft, turning counter-clockwise. Using hand pressure only, tighten the trimmer head firmly on the output shaft.

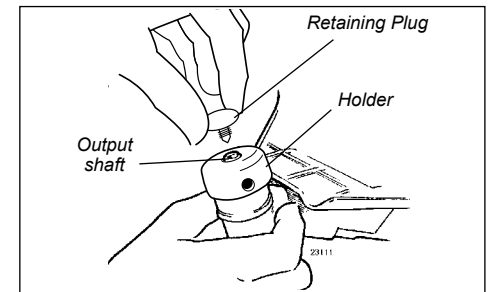

IMPORTANT!

The trimmer head has a left-hand thread. For removal turn the trimmer head clockwise.

5. Remove the hex wrench.
6. Adjust the trimmer line length to reach no further than the line cutter on the cutting attachment shield. Trim to the correct length if necessary.

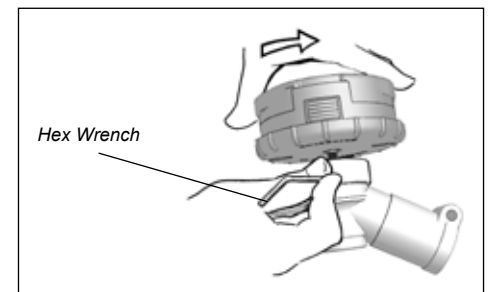

The unit should now be completely assembled and ready for use with a trimmer head.

**WARNING!**

A standard grass trimmer with a loop handle should NEVER be operated with blade-type attachments. For blade use the trimmer must be fitted with a bicycle-type handlebar or a barrier bar that is located in front of the operator to reduce the risk of the operator from coming in contact with the cutting attachment (per ANSI B175.3). When using a blade, the unit must also be equipped with a harness or strap.

Mixing Fuel

NOTICE: Use of unmixed, improperly mixed, or fuel older than 90 days, (stale fuel), may cause hard starting, poor performance, or severe engine damage and void the product warranty. Read and follow instructions in the Long Term Storage section of this manual.

**WARNING**

Alternative fuels, such as E15 (15% ethanol), E-85 (85% ethanol) or any fuels not meeting Shindaiwa requirements are NOT approved for use in Shindaiwa 2-stroke gasoline engines. Use of alternative fuels may cause performance problems, loss of power, overheating, fuel vapor lock, and unintended machine operation, including, but not limited to, improper clutch engagement. Alternative fuels may also cause premature deterioration of fuel lines, gaskets, carburetors and other engine components.

Fuel Requirements

Gasoline - Use 89 Octane [R+M/2] (mid grade or higher) gasoline known to be good quality. Gasoline may contain up to 10% Ethanol (grain alcohol) or 15% MTBE (methyl tertiary-butyl ether). Gasoline containing methanol (wood alcohol) is **NOT** approved.

2 Stroke Mixture Oil - A 2-stroke engine oil meeting ISO-L-EGD (ISO/CD 13738) and J.A.S.O. FD standards must be used. Shindaiwa One 2-Stroke Oil is strongly recommended as it meets this standard and is specifically formulated for use in all Shindaiwa 2-stroke engines. Engine problems due to inadequate lubrication caused by failure to use an ISO-L-EGD (ISO/CD 13738) and J.A.S.O. FD certified oil will void the engine warranty.

For increased engine protection, Shindaiwa recommends using Shindaiwa Red Armor engine oil to protect the engine from harmful carbon build up, maintain engine performance, and increase engine life. Red Armor engine oil exceeds ISO-L-EGD and J.A.S.O. FD performance requirements.

IMPORTANT!

Shindaiwa One 2-Stroke oil or Red Armor engine oil may be mixed at 50:1 ratio for application in all Shindaiwa engines sold in the past, regardless of ratio specified in those manuals.

IMPORTANT!

Stored fuel ages. Do not mix more fuel than you expect to use in thirty (30) days, ninety (90) days when a fuel stabilizer is added.

Examples of 50:1 mixing quantities

Fuel to Oil Mix - 50:1 Ratio			
U.S.		METRIC	
GAS	OIL	GAS	OIL
Gallons	Fl. oz.	Liter	cc.
1	2.6	4	80
2	5.2	8	160
5	13	20	400

Handling Fuel



DANGER

Fuel is VERY flammable. Use extreme care when mixing, storing or handling or serious personal injury may result.

- Use an approved fuel container.
- DO NOT smoke near fuel.
- DO NOT allow flames or sparks near fuel.
- Fuel tanks/cans may be under pressure. Always loosen fuel caps slowly allowing pressure to equalize.
- NEVER refuel a unit when the engine is HOT or RUNNING!
- DO NOT fill fuel tanks indoors. ALWAYS fill fuel tanks outdoors over bare ground.
- DO NOT overfill fuel tank. Wipe up spills immediately.
- Securely tighten fuel tank cap and close fuel container after refueling.
- Inspect for fuel leakage. If fuel leakage is found, do not start or operate unit until leakage is repaired.
- Move at least 3m (10 ft.) from refueling location before starting the engine.

Mixing Instructions

1. Fill an approved fuel container with half of the required amount of gasoline.
2. Add the proper amount of 2-stroke oil to gasoline.
3. Close container and shake to mix oil with gasoline.
4. Add remaining gasoline, close fuel container, and remix.

IMPORTANT!

Spilled fuel is a leading cause of hydrocarbon emissions. Some states may require the use of automatic fuel shut-off containers to reduce fuel spillage.

After use

- DO NOT store a unit with fuel in its tank. Leaks can occur. Return unused fuel to an approved fuel storage container.

Storage - Fuel storage laws vary by locality. Contact your local government for the laws affecting your area. As a precaution, store fuel in an approved, airtight container. Store in a well-ventilated, unoccupied building, away from sparks and flames.

IMPORTANT!

Stored two-stroke fuel may separate. ALWAYS shake fuel container thoroughly before each use.

Filling the fuel tank



WARNING!

Minimize the Risk of Fire

- NEVER smoke or light fires near the engine.
- ALWAYS stop the engine and allow it to cool before refueling.
- ALWAYS Wipe all spilled fuel and move at least 3 meters (10 feet) from the fueling point and source before starting.
- NEVER place flammable material close to the engine muffler.
- NEVER operate the engine without the muffler and spark arrester screen in place and in good working condition.
- FUEL IS HIGHLY FLAMMABLE.
- ALWAYS store gasoline in a container approved for flammable liquids.
- ALWAYS inspect the unit for fuel leaks before each use. During each refill, check that no fuel leaks from around the fuel cap and/or fuel tank. If fuel leaks are evident, stop using the unit immediately. Fuel leaks must be repaired before using the unit.
- ALWAYS move the unit at least 3 meters (10 feet) away from a fuel storage area or other readily flammable materials before starting the engine.

1. Place the unit on a flat, level surface.
2. Clear any dirt or other debris from around the fuel filler cap.

CAUTION!

Slowly remove the fuel cap only after stopping the engine

3. Remove the fuel cap, and fill the tank with clean, fresh fuel.
4. Reinstall the fuel filler cap and tighten firmly.
5. Wipe away any spilled fuel before starting engine.

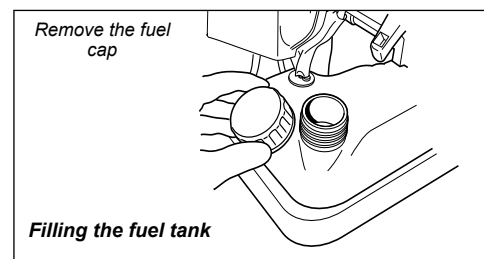

Starting the Engine

IMPORTANT!

Engine ignition is controlled by a two position switch mounted on the throttle housing labeled, "I" for ON or START and "O" for OFF or STOP.



WARNING!

The attachment will operate immediately when the engine starts and could result in loss of control and possible serious injury. Keep movable parts of the attachment away from objects that could become entangled or thrown.



WARNING!

Never start the engine from the operating position.

1. Slide the ignition switch to the "I" position.

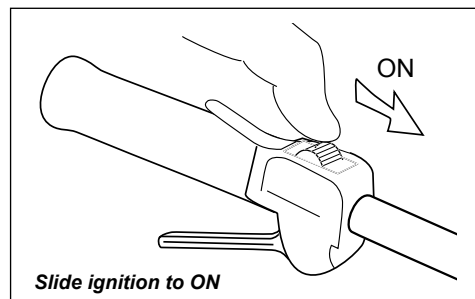

2. Press the primer bulb until fuel can be seen flowing in the transparent return tube.

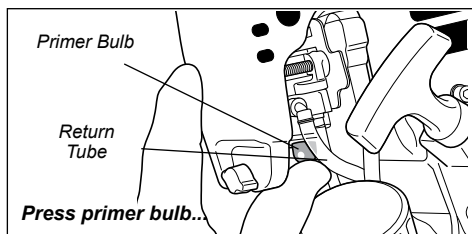

3. Set the choke lever to the CLOSED position if engine is cold.

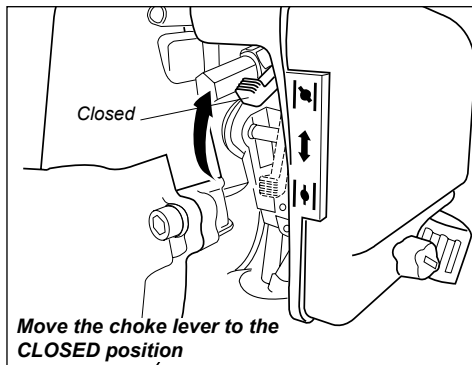

4. While holding the outer tube firmly with left hand. Use your other hand to slowly pull the recoil starter handle until resistance is felt, then pull quickly to start the engine.

IMPORTANT!

The primer system only pushes fuel through the carburetor. Repeatedly pressing the primer bulb will not flood the engine with fuel.

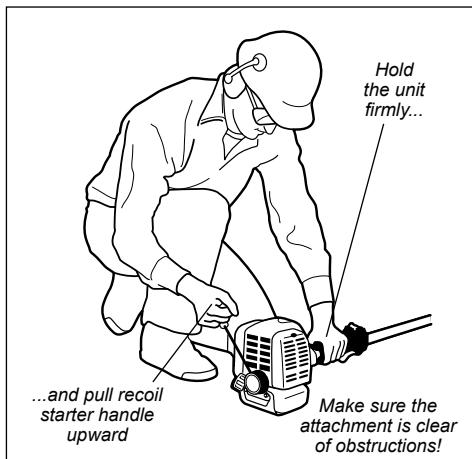

Starting the Engine (continued)

- When the engine starts, slowly move the choke lever to the "OPEN" position. If the engine stops after the initial start, close the choke and restart.

CAUTION!

Do not pull the recoil starter to the end of the rope travel. Pulling the recoil starter to the end of the rope travel can damage the starter.



WARNING!

The cutting attachment may rotate when the engine is started!



WARNING!

Keep all parts of your body away from the rotating cutting attachment and hot surfaces.

IMPORTANT!

If the engine fails to start after several attempts with the choke in the closed position, the engine may be flooded with fuel. If flooding is suspected, move the choke lever to the open position and repeatedly pull the recoil starter to remove excess fuel and start the engine. If the engine still fails to start, refer to the troubleshooting section of this manual.

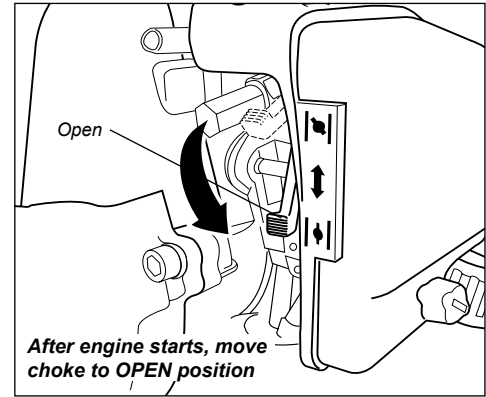

When the Engine Starts...

- After the engine starts, allow the engine to warm up at idle 2 or 3 minutes before operating the unit.
- After the engine is warm, pick up the unit and clip on the shoulder strap, if so equipped.
- Squeezing the throttle lever makes the cutting attachment move faster; releasing the throttle permits the attachment to stop moving. If the cutting attachment continues to move when the engine returns to idle, carburetor idle speed should be adjusted (see "Adjusting Engine Idle.")

Starting A Flooded Engine

- Slide the ignition switch to the "I" (ON) position.
- Open the choke, put the throttle lever in the full throttle position, then clear excess fuel from the combustion chamber by cranking the engine several times.
- If the engine still fails to start or fire, refer to the troubleshooting flow chart at the end of this manual.

Stopping the Engine

Idle the engine briefly before stopping (about 2 minutes), then slide the ignition switch to the "O" (Engine OFF) position.

CAUTION!

A coasting blade can cause injury while it continues to spin after the engine is stopped or throttle trigger is released. Maintain proper control until the blade has completely stopped rotating.

IMPORTANT!

When the unit is turned off make sure the cutting attachment has stopped before the unit is set down.

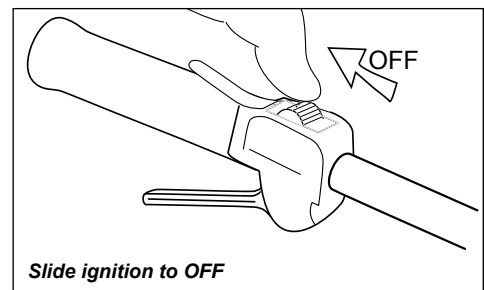

Checking Unit Condition

NEVER operate the unit with the cutting attachment shield or other protective devices removed!

Use only authorized Shindaiwa parts and accessories with your Shindaiwa trimmer. Do not make modifications to this unit without written approval from Shindaiwa, Inc.

ALWAYS make sure the cutting attachment is properly installed and firmly tightened before operation.

NEVER use a cracked or warped cutting attachment: replace it with a serviceable one.

The cutting attachment may be spinning during carburetor adjustments. Wear your protective equipment and observe all safety instructions.

ALWAYS make sure the cutting attachment fits properly into the appropriate attachment holder. If a properly installed attachment vibrates, replace the attachment with new one and re-check.

ALWAYS stop the engine immediately and check for damage if you strike a foreign object or if the unit becomes tangled. Do not operate with broken or damaged equipment.

NEVER allow the engine to run at high RPM without a load. Doing so could damage the engine.

NEVER operate a unit with worn or damaged fasteners or attachment holders.

When transporting, make sure the engine is not running and the blade is covered with the blade cover.



WARNING!

A cutting attachment shield or other protective device is no guarantee of protection against ricochet. **YOU MUST ALWAYS GUARD AGAINST FLYING DEBRIS!**

Operation



WARNING!

Moving parts can amputate fingers or cause severe injuries. Keep hands, clothing and loose objects away from all openings. Always stop engine, disconnect spark plug, and make sure all moving parts have come to a complete stop before removing obstructions, clearing debris, or servicing unit.



WARNING!

Engine exhaust IS HOT, and contains Carbon Monoxide (CO), a poison gas. Breathing CO can cause unconsciousness, serious injury, or death. Exhaust can cause serious burns. **ALWAYS** position unit so that exhaust is directed away from your face and body..



WARNING!

Operation of this equipment may create sparks that can start fires. This unit is equipped with a spark arrestor to prevent discharge of hot particles from the engine. Metal blade use also can create sparks if the blade strikes rocks, metal, or other hard objects. Contact local fire authorities for laws or regulations regarding fire prevention requirements.

Cutting grass with a trimmer head

Your Shindaiwa unit may be equipped with one of several Shindaiwa trimmer head models, each with features for specific applications and/or operational requirements.

NOTE:

For proper operation, always refer to the instructions accompanying the trimmer head being used.

Trimmer head styles:

Semi-automatic. Trimmer line is indexed when the operator taps the trimmer head on the ground during operation.

Manual. The operator indexes line manually with the grass trimmer stopped.

Fixed. The operator must stop the unit and add new lengths of trimmer line manually.

Flail. This device, designed for clearing weeds and light brush, features three nylon blades attached to the head by pivots.

NOTE:

Additional hardware may be required to mount the Fixed Line or the Flail type trimmer heads.

Engine Operating Speeds

Operate at full throttle while cutting grass.

Trimming and Mowing Grass

Hold the grass trimmer so the trimmer head is angled slightly into the area to be cut. To ensure maximum trimmer-line service life, cut only with the tip of the trimmer line. Cut grass by swinging the unit's trimmer head from left to right. Keep the trimmer head horizontal.



CAUTION!

Use only flexible, nonmetallic line recommended by the manufacturer. Never use, for example, wire or wire-rope, which can break off and become a dangerous projectile.

CAUTION!

- Do not push the rotating line into trees, wire fences or any material that could tangle or break line ends.
- Operation of trimmer without a cutting attachment shield and using excessive line length can lead to premature clutch failure.
- Operation at low rpm can lead to premature clutch failure.



WARNING!

Remove all objects such as rocks, broken glass, nails, wire, or string, which can be thrown or become entangled in the cutting attachment.

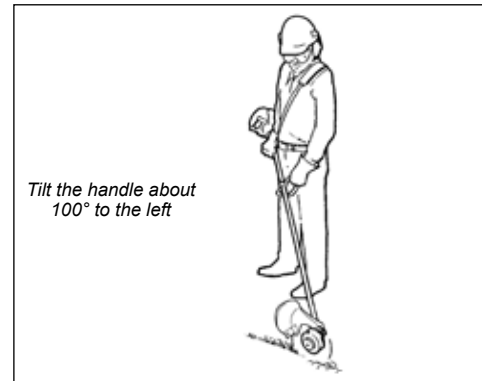

Edging

Tilt the handle about 100° to the left (from horizontal) and move forward, holding the trimmer or brushcutter vertically as shown.

Maintenance

General maintenance

IMPORTANT!

MAINTENANCE, REPLACEMENT OR REPAIR OF EMISSION CONTROL DEVICES AND SYSTEMS MAY BE PERFORMED BY ANY REPAIR ESTABLISHMENT OR INDIVIDUAL; HOWEVER, WARRANTY REPAIRS MUST BE PERFORMED BY A DEALER OR SERVICE CENTER AUTHORIZED BY ECHO, INC. THE USE OF PARTS THAT ARE NOT EQUIVALENT IN PERFORMANCE AND DURABILITY TO AUTHORIZED PARTS MAY IMPAIR THE EFFECTIVENESS OF THE EMISSION CONTROL SYSTEM AND MAY HAVE A BEARING ON THE OUTCOME OF A WARRANTY CLAIM.

NOTE:

Using non-standard replacement parts could invalidate your Shindaiwa warranty.



WARNING!

Before performing any maintenance, repair, or cleaning work on the unit, make sure the engine and cutting attachment are completely stopped. Disconnect the spark plug wire before performing service or maintenance.



WARNING!

Non-standard accessories, cutting attachment, or replacement parts may not operate properly with your unit and may cause damage and lead to personal injury.

Muffler

This unit must never be operated with a faulty or missing spark arrester or muffler. Make sure the muffler is well secured and in good condition. A worn or damaged muffler is a fire hazard and may also cause hearing loss.

Spark Plug

Keep the spark plug and wire connections tight and clean.

Fasteners

Make sure nuts, bolts, and screws (except carburetor adjusting screws) are tight.

Daily Maintenance

Prior to each work day, perform the following:

- Remove dirt or debris from the engine, check the cooling fins and air cleaner for clogging and clean them as necessary.
- Carefully remove any accumulation of dirt or debris from the muffler or the fuel tank. Dirt build-up in these areas could cause engine overheating, induce premature wear, or create a fire hazard.
- Check for loose or missing screws or components. Make sure the cutting attachment is securely fastened.
- Check the entire unit for leaking fuel or grease.

10-Hour Maintenance

Every 10 hours of operation

(more frequently in dusty or dirty conditions):

- Remove the air cleaner element. Clean or replace as necessary. To clean element: wash it thoroughly in soap and water. Let it dry before reinstalling the element.

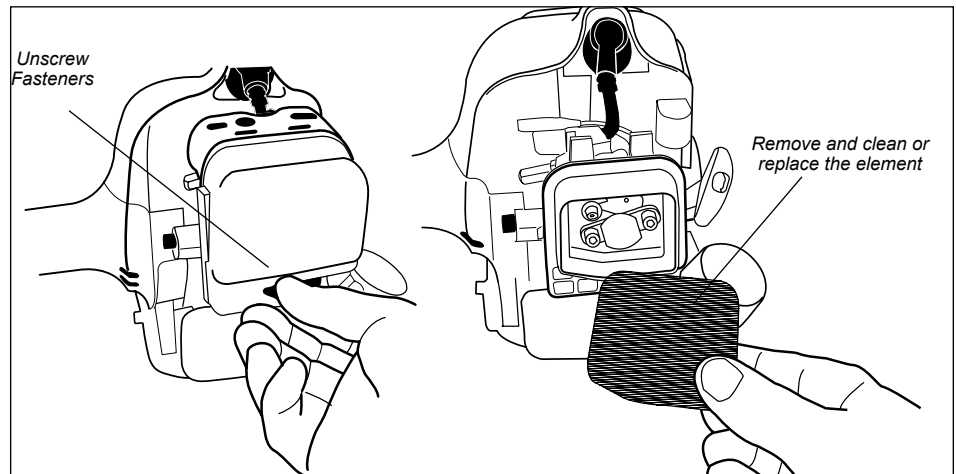

CAUTION!

Do not operate the unit if the air cleaner or filter is damaged, or if the filter is wet or water soaked.

10/15-Hour Maintenance

Every 10 to 15 hours of operation:

- Remove and clean the spark plug. Adjust the spark plug electrode gap 0.6 mm to (0.024 inch). If the spark plug must be replaced, use only an BPMR6A or equivalent resistor type spark plug of the correct heat range.

CAUTION!

Before removing the spark plug, clean the area around the plug to prevent dirt and debris from getting into the engine's internal parts.

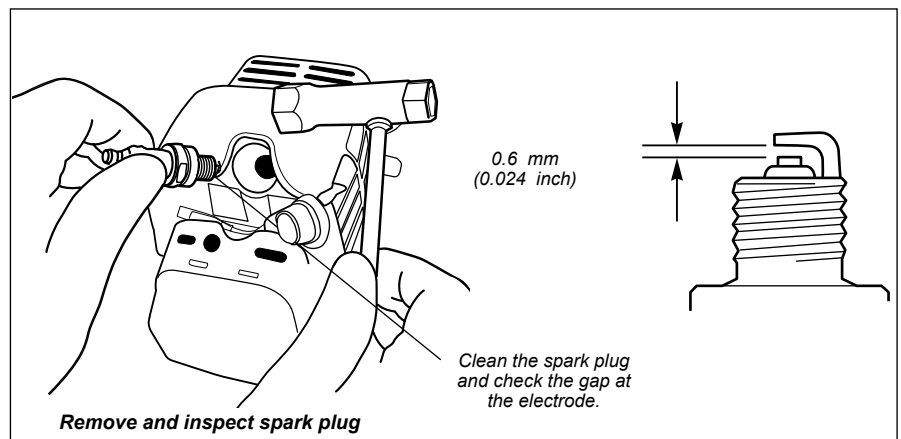

Remove and replace the filter element.

- Use a hooked wire to extract the fuel filter from inside the fuel tank.

Before reinstalling the new filter element, inspect the condition of all the fuel system components (fuel pick-up line, fuel return line, tank vent line, tank vent, fuel cap and fuel tank). If damage, splitting or deterioration is noted, the unit should be removed from service until it can be inspected or repaired by a Shindaiwa-trained service technician.

CAUTION!
Make sure you do not pierce the fuel line with the end of the hooked wire. The line is delicate and can be damaged easily.

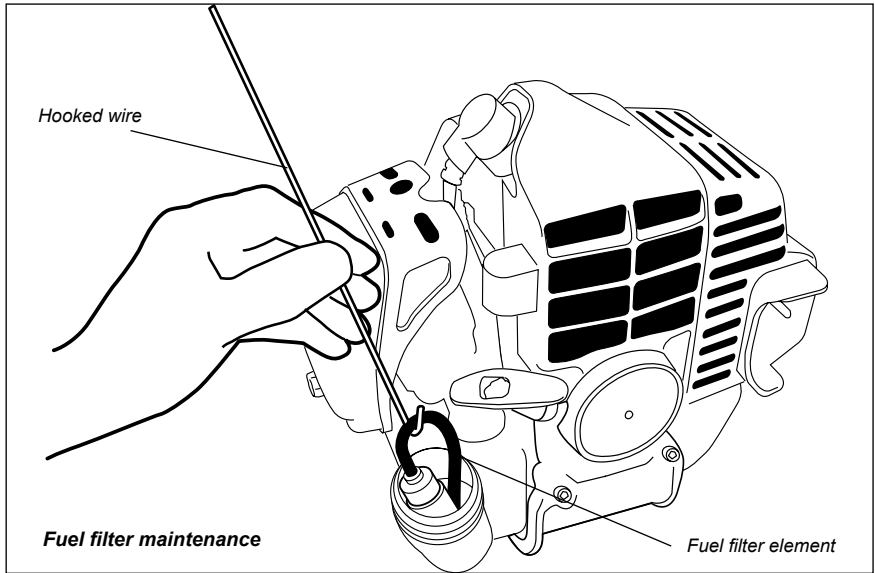

NOTE:

Federal EPA regulations require all model year 2012 and later gasoline powered engines produced for sale in the United States to be equipped with a special low permeation fuel supply hose between the carburetor and fuel tank. When servicing model year 2012 and later equipment, only fuel supply hoses certified by EPA can be used to replace the original equipment supply hose. Fines up to \$37,500 may be enforced for using an un-certified replacement part.

Lubrication Gearcase

Every 50 hours of operation:

Without cutting attachment installed on gear case:

- Remove the cutting attachment, cutting attachment holder and gear shaft collar. Remove the filler plug from the side of the gear case and press new grease into the gear case until old grease is pushed out. Use only lithium-base grease such as Shindaiwa Gear Case Lubricant or equivalent.
- Remove mainshaft and lubricate both ends of the splines.

With cutting attachment installed on gear case:

- Remove the filler plug and drain screw from the side of the gear case and press new grease into the gear case until old grease is pushed out. Use only lithium-base grease such as Shindaiwa Gear Case Lubricant or equivalent.
- Remove mainshaft and lubricate both ends of the splines.

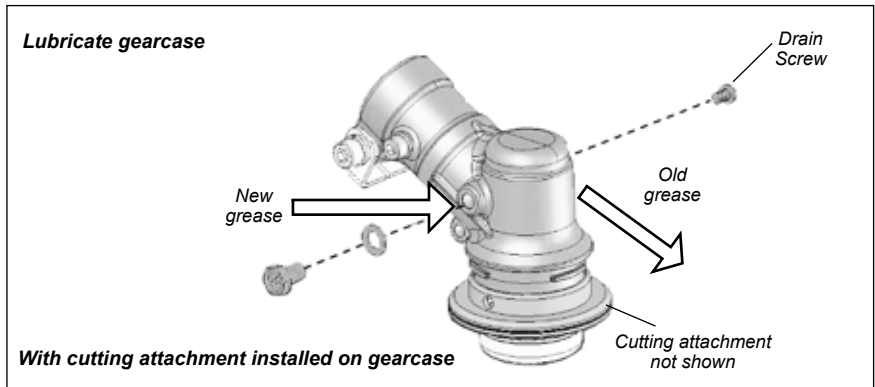
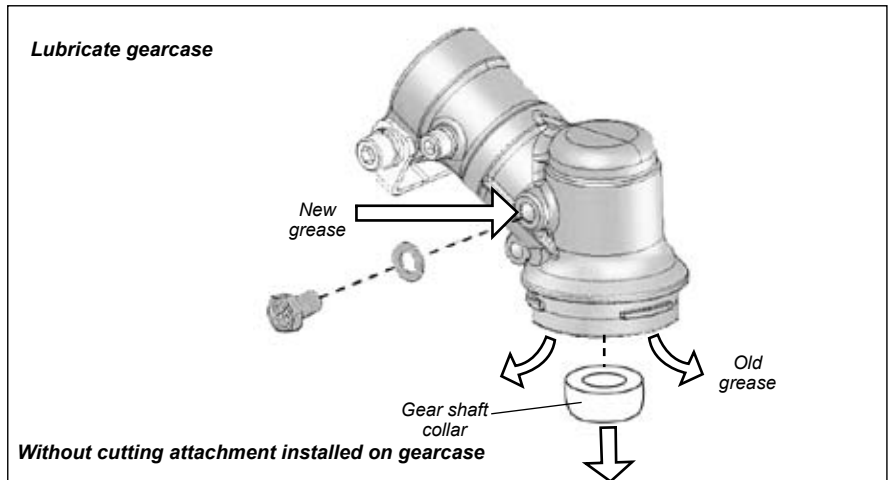

Cooling System

Muffler and spark arrester maintenance

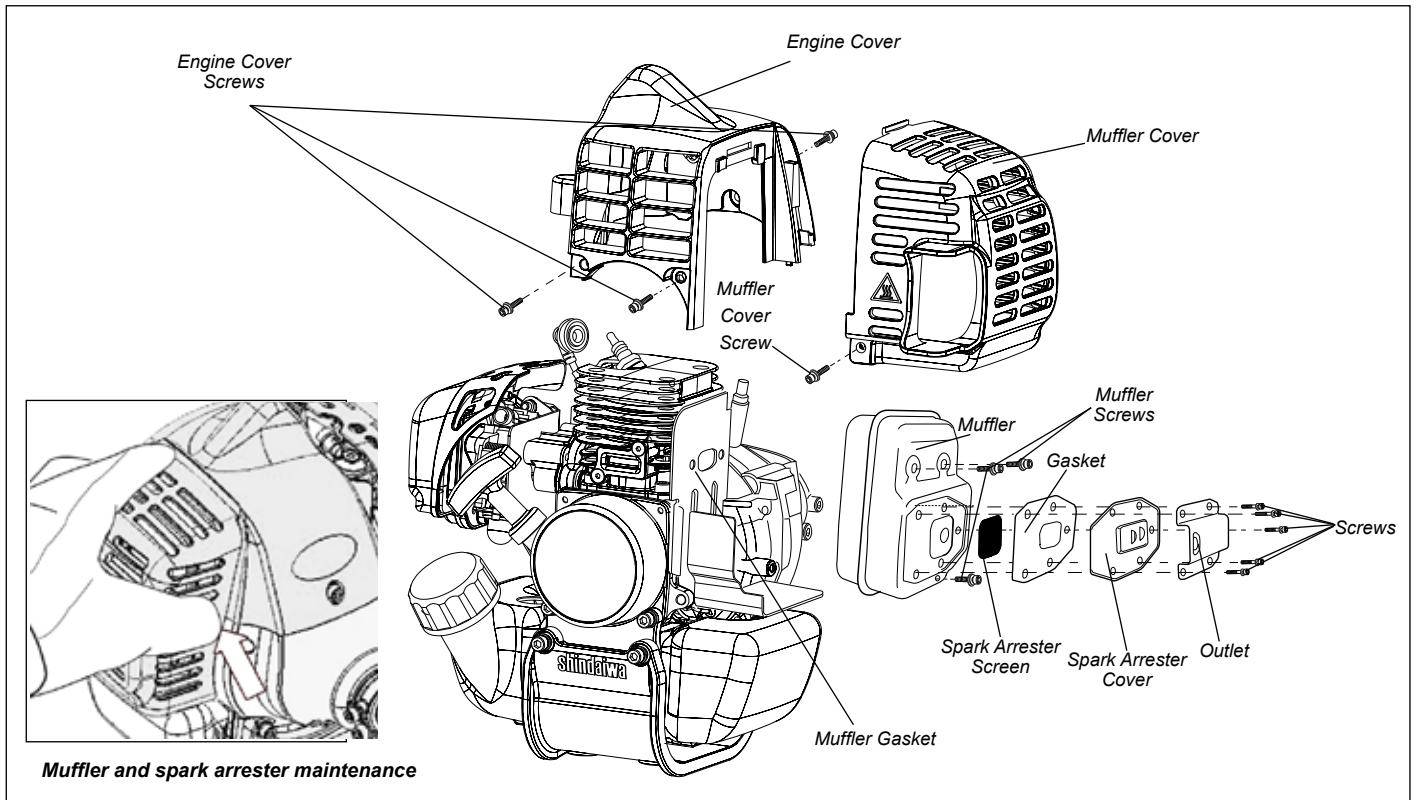

WARNING!

Never operate the unit with a damage or missing muffler or spark arrester! Operating with a missing or damaged spark arrester is a fire hazard and could also damage your hearing.

If the engine becomes sluggish and low on power, check and clean the spark arrester screen.

1. Remove the spark plug boot.
2. With a 4mm hex wrench remove the 1 muffler cover and 3 engine cover screws and the engine cover. The muffler cover is attached to the engine cover at the top and front by tabs. To remove push inward at arrow area while pulling outward. See insert image.
3. With a Phillips type screwdriver remove the 5 screws holding the spark arrester screen and cover to the muffler.
4. Remove the screen and clean it with a stiff bristle brush.
5. Remove the 3 muffler bolts and the muffler.
6. Inspect the cylinder exhaust port for any carbon buildup.
7. Gently tap the muffler on a wood surface to dislodge any loose carbon.
8. Reassemble the spark arrester, muffler and engine cover in the reverse order of disassembly.

IMPORTANT!

If you note excessive carbon buildup, consult with an authorized Shindaiwa servicing dealer.

Carburetor Adjustment

Engine Break-In

New engines must be operated a minimum duration of two tanks of fuel break-in before carburetor adjustments can be made. During the break-in period your engine performance will increase and exhaust emissions will stabilize. Idle speed can be adjusted as required.

High Altitude Operation

This engine has been factory adjusted to maintain satisfactory starting, emission, and durability performance up to 1,100 feet above sea level (ASL) (96.0 kPa). To maintain proper engine operation and emission compliance above 1,100 feet ASL the carburetor may need to be adjusted by an authorized ECHO service dealer.

IMPORTANT!

If the engine is adjusted for operation *above* 1,100 feet ASL, the carburetor must be re-adjusted when operating the engine *below* 1,100 feet ASL, otherwise severe engine damage may result.

NOTE:

Every unit is run at the factory and the carburetor is set in compliance with emission regulations. Carburetor adjustments, other than idle speed, must be performed by an authorized Shindaiwa dealer..



WARNING!

When carburetor adjustment is completed, the cutting attachment should not move at idle, otherwise serious personal injury may result.

The engine must return to idle speed whenever the throttle lever is released. Idle speed is adjustable, and must be set low enough to permit the engine clutch to disengage the cutting attachment.

Adjusting Engine Idle

The engine must return to idle speed whenever the throttle lever is released. Idle speed is adjustable, and must be set low enough to permit the engine clutch to disengage the cutting attachment.



WARNING!

The cutting attachment must NEVER rotate at engine idle! If the idle speed cannot be adjusted by the procedure described here, return the trimmer to your Shindaiwa dealer for inspection.

Idle Speed Adjustment

1. Place the trimmer on the ground, then start the engine, and then allow it to idle 2-3 minutes until warm.
2. If the attachment rotates when the engine is at idle, reduce the idle speed by turning the idle adjustment screw counter-clockwise.
3. If a tachometer is available, the engine idle speed should be final adjusted to 3,000 (± 250) min^{-1} (rpm).
4. Carburetor fuel mixture adjustments are preset at factory and cannot be serviced in the field.

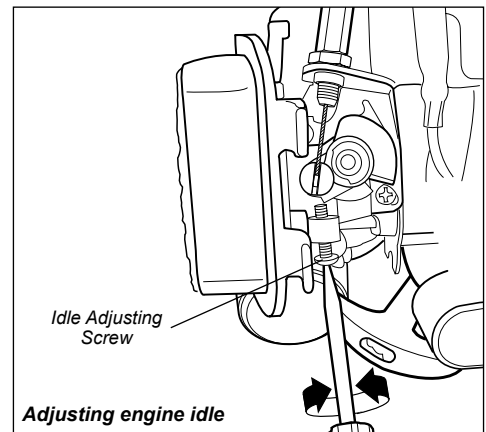

Loading Speed-Feed® Trimmer Line

1. Cut one piece of line to recommended length.
.080 (2.0 mm) dia. - 20' (6 m)
.095 (2.4 mm) dia. - 20' (6 m)
2. Align arrows on top of knob with openings in eyelets.
3. Insert one end of trimmer line into an eyelet, and push line equal distance through trimmer head.
4. Hold trimmer head while turning knob clockwise to wind line onto spool until about 5" (13 cm) of each line remains exposed.

Trimmer head is now fully loaded and ready for operation.

NOTE:

Trimmer head is pre-wound with .095" (2.4mm) Crossfire™ trimmer line.

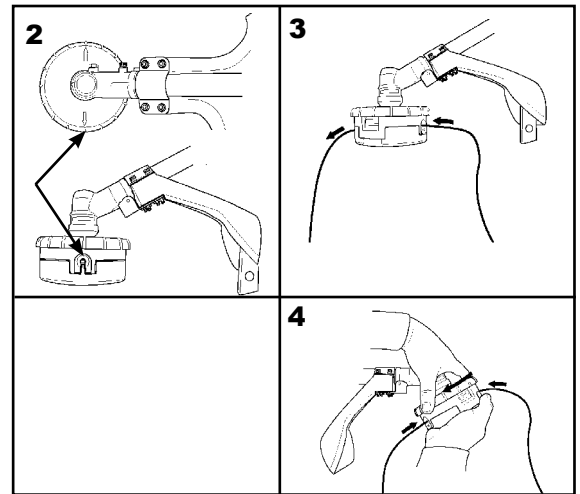

IMPORTANT!

When the wear indicators located at the bottom of the Speed-Feed head are worn smooth, replacement of the cover or the entire Speed-Feed head is required.



Long Term Storage

Whenever the unit will not be used for 30 days or longer, use the following procedures to prepare it for storage:

- Clean external parts thoroughly and apply a light coating of oil to all metal surfaces.
- Drain all the fuel from the carburetor and the fuel tank.

To do so:

1. Prime the primer bulb until no more fuel is passing through.
2. Start and run the engine until it stops running.
3. Repeat steps 1 and 2 until the engine will no longer start.

CAUTION!

Gasoline stored in the carburetor for extended periods can cause hard starting, and could also lead to increased service and maintenance costs.

IMPORTANT!

All stored fuels should be stabilized with a fuel stabilizer such as STA-BIL™.

NOTE:

Damage resulting from stale or contaminated fuel is not covered by the Shindaiwa warranty policy.

- Remove the spark plug and pour about 1/4 oz. of engine oil into the cylinder through the spark plug hole. Slowly pull the recoil starter 2 or 3 times so oil will evenly coat the interior of the engine. Reinstall the spark plug.
- Before storing the unit, repair or replace any worn or damaged parts.
- Remove the air cleaner element from the carburetor and clean it thoroughly with soap and water. Let dry and reassemble the element.
- Store the unit in a clean, dust-free area.

Troubleshooting Guide

ENGINE DOES NOT START OR HARD TO START

What To Check	Possible Cause	Remedy
Vaporlock.	<ul style="list-style-type: none"> Engine hot/heat soaked. Low fuel quality. 	<ul style="list-style-type: none"> Let cool completely and restart. Refill with fresh, clean unleaded gasoline with a pump octane of 89 or higher mixed with an air cooled engine oil that meets or exceeds ISO-L-EGD and/or JASO FD classified oils at 50:1 gasoline/oil ratio.

ENGINE DOES NOT START

What To Check	Possible Cause	Remedy
<p>Does the engine crank?</p> <p>NO</p> <p>YES</p>	<ul style="list-style-type: none"> Faulty recoil starter. Fluid in the crankcase. Internal damage. 	<ul style="list-style-type: none"> Consult with an authorized Shindaiwa servicing dealer.
<p>Good compression?</p> <p>NO</p> <p>YES</p>	<ul style="list-style-type: none"> Loose spark plug. Excess wear on cylinder, piston, rings. 	<ul style="list-style-type: none"> Tighten and re-test. Consult with an authorized Shindaiwa servicing dealer.
<p>Does the tank contain fresh fuel of the proper grade?</p> <p>NO</p> <p>YES</p>	<ul style="list-style-type: none"> Fuel incorrect, stale, or contaminated; mixture incorrect. 	<ul style="list-style-type: none"> Refill with fresh, clean unleaded gasoline with a pump octane of 89 or higher mixed with an air cooled engine oil that meets or exceeds ISO-L-EGD and/or JASO FD classified oils at 50:1 gasoline/oil ratio.
<p>Is fuel visible and moving in the return line when priming?</p> <p>NO</p> <p>YES</p>	<ul style="list-style-type: none"> Check for clogged fuel filter and/or vent. Priming pump not functioning properly. 	<ul style="list-style-type: none"> Replace fuel filter or vent as required. Re-start. Consult with an authorized Shindaiwa servicing dealer.
<p>Is there spark at the spark plug wire terminal?</p> <p>NO</p> <p>YES</p>	<ul style="list-style-type: none"> The ignition switch is in "O" (OFF) position. Shorted ignition ground. Faulty ignition unit. 	<ul style="list-style-type: none"> Move switch to "I" (ON) position and re-start. Consult with an authorized Shindaiwa servicing dealer.
<p>Check the spark plug.</p>	<ul style="list-style-type: none"> If the plug is wet, excess fuel may be in the cylinder. The plug is fouled or improperly gapped. The plug is damaged internally or of the wrong size. 	<ul style="list-style-type: none"> See "Starting a Flooded Engine" Clean and gap the spark plug. Check the Specifications section for the correct plug and gap for your unit. Restart. Replace the spark plug. Check the Specifications section for the correct plug and gap for your unit. Restart.

Troubleshooting Guide (continued)

LOW POWER OUTPUT

What To Check	Possible Cause	Remedy
Is the engine overheating?	Operator is overworking the unit.	Use a lower throttle setting.
	Carburetor mixture is too lean.	Consult with an authorized Shindaiwa servicing dealer.
	Improper fuel ratio.	Refill with fresh, clean unleaded gasoline with a pump octane of 89 or higher mixed with an air cooled engine oil that meets or exceeds ISO-L-EGD and/or JASO FD classified oils at 50:1 gasoline/oil ratio.
	Fan, fan cover, cylinder fins dirty or damaged.	Clean, repair or replace as necessary.
	Carbon deposits on the piston or in the muffler.	Consult with an authorized Shindaiwa servicing dealer.
Engine is rough at all speeds. May also have black smoke and/or unburned fuel at the exhaust.	Clogged air cleaner element.	Service the air cleaner element.
	Loose or damaged spark plug.	Tighten or replace the spark plug. Check the <i>Specifications</i> section for the correct plug and gap for your unit.
	Air leakage or clogged fuel line.	Repair or replace fuel filter and/or fuel line.
	Water in the fuel.	Refill with fresh, clean unleaded gasoline with a pump octane of 89 or higher mixed with an air cooled engine oil that meets or exceeds ISO-L-EGD and/or JASO FD classified oils at 50:1 gasoline/oil ratio.
	Piston seizure.	Consult with an authorized Shindaiwa servicing dealer.
	Faulty carburetor and/or diaphragm.	
Engine is knocking.	Overheating condition.	Consult with an authorized Shindaiwa servicing dealer.
	Improper fuel.	Refill with fresh, clean unleaded gasoline with a pump octane of 89 or higher mixed with an air cooled engine oil that meets or exceeds ISO-L-EGD and/or JASO FD classified oils at 50:1 gasoline/oil ratio.
	Carbon deposits in the combustion chamber.	Consult with an authorized Shindaiwa servicing dealer.

Troubleshooting Guide (continued)

ADDITIONAL PROBLEMS

Symptom	Possible Cause	Remedy
<div style="border: 1px solid black; padding: 5px; width: fit-content;">Poor acceleration.</div>	Clogged air filter.	Clean the air filter.
	Clogged fuel filter.	Replace the fuel filter.
	Lean fuel/air mixture.	Consult with an authorized Shindaiwa servicing dealer.
	Idle speed set too low.	Adjust idle. Check <i>Specifications</i> page for correct idle speed.
<div style="border: 1px solid black; padding: 5px; width: fit-content;">Engine stops abruptly.</div>	Ignition switch turned off.	Reset the switch and re-start.
	Fuel tank empty.	Refill with fresh, clean unleaded gasoline with a pump octane of 89 or higher mixed with an air cooled engine oil that meets or exceeds ISO-L-EGD and/or JASO FD classified oils at 50:1 gasoline/oil ratio.
	Water in the fuel.	
	Clogged fuel filter.	Replace fuel filter.
	Shorted spark plug or loose terminal.	Clean or replace spark plug. Check the <i>Specifications</i> section for the correct plug and gap for your unit. Tighten the terminal.
	Ignition failure.	Replace the ignition unit.
Piston seizure.	Consult with an authorized Shindaiwa servicing dealer.	
<div style="border: 1px solid black; padding: 5px; width: fit-content;">Engine difficult to shut off.</div>	Ground (stop) wire is disconnected, or switch is defective.	Test and replace as required.
	Overheating due to incorrect spark plug.	Replace the spark plug. Check the <i>Specifications</i> section for the correct plug and gap for your unit. Restart.
	Overheated engine.	Idle engine until cool.
<div style="border: 1px solid black; padding: 5px; width: fit-content;">Engine will not idle down.</div>	Idle set too high.	Adjust idle. Check <i>Specifications</i> page for correct idle speed.
	Engine has an air leak.	Consult with an authorized Shindaiwa servicing dealer.
<div style="border: 1px solid black; padding: 5px; width: fit-content;">Cutting attachment moves at engine idle.</div>	Engine idle too high.	Adjust idle. Check <i>Specifications</i> page for correct idle speed.
	Broken clutch spring or worn clutch spring boss.	Replace spring/shoes as required, check idle speed.
<div style="border: 1px solid black; padding: 5px; width: fit-content;">Excessive vibration.</div>	Loose attachment holder.	Inspect and re-tighten holders securely.
	Warped or damaged attachment.	Inspect and replace attachment as required.
	Loose gearcase.	Tighten gearcase securely.
	Bent main shaft/worn or damaged bushings.	Inspect and replace as necessary.
<div style="border: 1px solid black; padding: 5px; width: fit-content;">Cutting attachment will not move.</div>	Shaft not installed in powerhead or gearcase.	Inspect and reinstall as required.
	Broken shaft.	Consult with an authorized Shindaiwa servicing dealer.
	Damaged gearcase.	

**SHINDAIWA LIMITED WARRANTY STATEMENT FOR
PRODUCT SOLD IN USA AND CANADA BEGINNING 01/01/2010**

ECHO, INC'S RESPONSIBILITY

ECHO Incorporated's (ECHO, INC.) Limited Warranty, provides to the original purchaser that this Shindaiwa product is free from defects in material and workmanship. Under normal use and maintenance from date of purchase, ECHO, INC. agrees to repair or replace at it's discretion, any defective product free of charge at any authorized Shindaiwa servicing dealer within listed below application time periods, limitations and exclusions. **THIS LIMITED WARRANTY IS ONLY APPLICABLE TO SHINDAIWA PRODUCTS SOLD BY AUTHORIZED SHINDAIWA DEALERS. IT IS EXTENDED TO THE ORIGINAL PURCHASER ONLY, AND IS NOT TRANSFERABLE TO SUBSEQUENT OWNERS EXCEPT FOR EMISSION RELATED PARTS.** Repair parts and accessories replaced under this warranty are warranted only for the balance of the original unit or accessory warranty period. Any damage caused by improper installation or improper maintenance is not covered by this warranty. All parts or products replaced under warranty become the property of ECHO, INC. This warranty is separate from the Emission control warranty statement supplied with your new product. Please consult the Emission Control Warranty Statement for details regarding emission related parts. For a list of Authorized Shindaiwa Dealers refer to WWW.SHINDAIWA.COM or call **1-877-986-7783**.

OWNER'S RESPONSIBILITY

To ensure trouble free warranty coverage it is important that you register your Shindaiwa equipment on-line at WWW.SHINDAIWA.COM or by filling out the warranty registration card supplied with your unit. Registering your product confirms your warranty coverage and provides a direct link if we find it necessary to contact you.

The owner shall demonstrate reasonable care and use, and follow preventative maintenance, storage, fuel and oil usage as prescribed in the operator's manual. Should a product difficulty occur, you must, at your expense, deliver or ship your Shindaiwa unit to an authorized Shindaiwa servicing dealer for warranty repairs (within the applicable warranty period), and arrange for pick-up or return of your unit after the repairs have been made. For your nearest authorized Shindaiwa servicing dealer, call Shindaiwa's Dealer Referral Center, at 1-877-986-7783 or you can locate a Shindaiwa servicing dealer at WWW.SHINDAIWA.COM. Should you require assistance or have questions concerning Shindaiwa's Warranty Statement, you can contact our Consumer Product Support Department at 1-800-673-1558 or contact us through the web at WWW.SHINDAIWA.COM.

PRODUCT WARRANTY PERIOD

RESIDENTIAL APPLICATION

- **2 YEAR WARRANTY** - Units for residential, or non-income producing use will be covered by this limited warranty for two (2) years from date of purchase.

EXCEPTIONS:

- For engine powered products, the electronic ignition module, flexible drive cable, and solid drive shaft are warranted for the life* of the product on parts only.
- Cutting attachments such as, but not limited to, bars, chains, sprockets, tines, blades, PowerBroom™, belts, and nylon trimmer heads for residential or non-income producing use will be covered for failures due to defects in material or workmanship for a period of 60 days from original product purchase date. Any misuse from contact with concrete, rocks, or other structures is not covered by this warranty.
- Multipurpose Tool Attachments carry the same warranty duration as the units they are designed to fit.

COMMERCIAL APPLICATION

- **90 DAY WARRANTY** - All Chain Saws and Cut-Off Saws for commercial, institutional, agricultural, industrial, or income producing use will be covered by this limited warranty for 90 Days from the date of purchase.
- **2 YEAR WARRANTY** - Units for commercial, institutional, agricultural, industrial, or income producing use will be covered by this limited warranty for two (2) years from the date of purchase.

EXCEPTIONS:

- For engine powered products, the electronic ignition module, flexible drive cables, and solid drive shafts are warranted for the life* of the product on parts only.
- Cutting attachments such as, but not limited to, bars, chains, sprockets, tines, blades, PowerBroom™, belts, and nylon trimmer heads for commercial, institutional, agricultural, industrial, rental, or income producing will be covered for failures due to defects in material or workmanship for a period of 30 days from original product purchase date. Any misuse from contact with concrete, rocks, or other structures is not covered by this warranty.
- Multipurpose Tool Attachments carry the same warranty duration as the units they are designed to fit.

RENTAL APPLICATION - 90 DAYS WARRANTY

- Units for rental use will be covered against defects in material and workmanship for a period of 90 days from the date of purchase.

* ECHO INC's liability under the "Lifetime" coverage is limited to furnishing parts specified under the PRODUCT Warranty PERIOD section of this warranty statement for "Life" free of charge for a period of ten (10) years after the date of the complete unit's final production.

PURCHASED REPAIR PARTS AND ACCESSORIES

- 90-day all applications

ATTENTION ENGINE POWERED PRODUCT OWNERS

This Shindaiwa engine powered product is a quality-engineered unit which has been manufactured to exact tolerances to provide superior performance. To help ensure the performance of the unit, it is required to use engine oil which meets the ISO-L-EGD Standard per ISO/CD 13738 and JASO M345/FD Standards. Shindaiwa Red Armor™ and Shindaiwa One™ are a premium engine oil specifically formulated to meet ISO-L-EGD (ISO/CD 13738) and JASO M345/FD Standards. The use of engine oils designed for other applications, such as for outboard motors or lawnmowers can result in severe engine damage, and will void your engine limited warranty.

THIS WARRANTY DOES NOT COVER DAMAGE CAUSED BY:

- Lack of lubrication or engine failure, due to the use of engine oils that do not meet the ISO-L-EGD (ISO/CD 13738) and JASO M345/FD Standards. Shindaiwa Red Armor™ and Shindaiwa One™ Engine Oil meets the ISO-L-EGD and JASO M345/FD Standard. Emission related parts are covered for 2 years regardless of engine oil used, per the statement listed in the EPA or California Emission Control Warranty Explanation.
- Damage caused by use of gasohol, containing methanol (wood alcohol), or gasoline containing less than 89 octane. Only use gasoline which contains 89 octane or higher. Gasohol which contains a maximum 10% ethanol (grain alcohol) or 15% MTBE (methyl/tertiary/butyl/ether) is also approved. The prescribed mixing ratio of gasoline to oil is listed on the Shindaiwa oil label and covered in your operator's manual.
- Engine damage caused by use of ether or any starting fluids.
- Damage caused by tampering with engine speed governor or emission components, or running engines above specified and recommended engine speeds as listed in your operator's manual.
- Operation of the unit with improperly maintained/removed cutting shield or removed/damaged air filter.
- Damage caused by dirt, pressure or steam cleaning the unit, salt water, corrosion, rust, varnish, abrasives, and moisture.
- Defects, malfunctions or failures resulting from abuse, misuse, neglect, modifications, alterations, normal wear, improper servicing, or use of unauthorized attachments.
- Incorrect storage procedures, stale fuel, including failure to provide or perform required maintenance services as prescribed in the operator's manual. Preventative maintenance as outlined in the operator's manual is the customer's responsibility.
- Failures due to improper set-up, pre-delivery service or repair service by anyone other than authorized Shindaiwa servicing dealer during the warranty period.
- Certain parts and other items are not warranted, including but not limited to: lubricants, starter cords, and engine tune-ups.
- Use of spark plugs other than those meeting performance and durability requirements of the OEM spark plug listed in the Operator's Manuals.
- Overheating or carbon scoring failures due to restricted, clogged exhaust port or combustion chamber, including damage to spark arrester screen.
- Adjustments after the first (30) thirty days and beyond, such as carburetor adjustment and throttle cable adjustment.
- Damage to gears or gear cases caused by contaminated grease or oil, use of incorrect type or viscosity of lubricants, and/or failure to comply with recommended grease or oil change intervals.
- Damage caused by pump or sprayer running dry, pumping or spraying caustic or flammable materials, or lack of or broken strainers.
- Additional damage to parts or components due to continued use after operational problem or failure occurs. Should operational problem or failure occur, the product should not be used, but delivered as is to an authorized Shindaiwa servicing dealer.

It is a dealer's and/or customer's responsibility to complete and return the warranty registration card supplied with your Shindaiwa product or by visiting WWW.SHINDAIWA.COM. Your receipt of purchase including date, model and serial number must be maintained and presented to an authorized Shindaiwa servicing dealer for warranty service. Proof of purchase rests solely with the customer. Some states do not allow limitations on how long an implied warranty lasts, so the above limitations may not apply to you. Some states do not allow the exclusion or limitation of incidental or consequential damages, so you may also have other specific legal rights which vary from state to state. This limited warranty is given by ECHO Incorporated, 400 Oakwood Rd., Lake Zurich, IL 60047.

DISCLAIMER OF IMPLIED WARRANTIES

This limited warranty is in lieu of all other expressed or implied warranties, including any warranty of FITNESS FOR A PARTICULAR PURPOSE OR USE and any implied warranty of **MERCHANTABILITY** otherwise applicable to this product. ECHO, INC. and its affiliated companies shall not be liable for any special incidental or consequential damage, including lost profits. There are no warranties extended other than as provided herein. This limited warranty may be modified only by ECHO, INC.

99922201031
06/2010

**ECHO INCORPORATED EMISSION CONTROL WARRANTY STATEMENT
FOR ECHO AND SHINDAIWA BRANDS**

The Environmental Protection Agency (EPA) and the California Air Resources Board (C.A.R.B.) and ECHO Incorporated (ECHO Inc.) are pleased to explain the emission control system warranty on your 2010 and later equipment/small off-road engine (SORE). New equipment/SORE must be designed, built and equipped to meet stringent EPA and C.A.R.B. anti-smog standards. ECHO Inc. must warrant the emission control system on your equipment/SORE for the periods of time listed below, provided there has been no abuse, neglect or improper maintenance of your equipment/SORE. Your emission control system may include parts such as: carburetor, fuel-injection system, ignition system, catalytic converter/muffler, fuel tank, fuel feed lines, fuel cap assembly, spark plug, air filters, and other associated components. Where a warrantable condition exists, ECHO Inc will repair your equipment/SORE at no cost to you including diagnosis, parts and labor. The Emission Control System warranty is extended to the original owner including all subsequent owners.

MANUFACTURER'S WARRANTY COVERAGE:

The emission control system is warranted for 2 years or the length of the ECHO Inc. warranty, whichever is longer. If any emission-related part on your equipment is defective, the part will be repaired or replaced by ECHO Inc. or its Authorized Service Representative.

OWNER'S WARRANTY RESPONSIBILITIES:

As the equipment/SORE owner, you are responsible for the performance of the required maintenance listed in your Operator's Manual. ECHO Inc. recommends that you retain all receipts covering maintenance on your equipment/SORE however, ECHO Inc. cannot deny warranty solely for the lack of receipts or for your failure to ensure the performance of all scheduled maintenance. As the equipment/SORE owner, you should be aware that ECHO Inc. may deny you warranty coverage if your equipment/SORE or a part has failed due to abuse, neglect, improper maintenance or unapproved modifications.

You are responsible for presenting your equipment/SORE to an ECHO Inc. authorized service representative as soon as a problem exists. The warranty repairs should be completed in a reasonable amount of time, not to exceed 30 days. If a warrantable condition exists and there is no Authorized Dealer within 100 miles, ECHO Inc. will pay to ship the unit to the nearest authorized dealer. If you have questions regarding your warranty coverage, you should contact ECHO Inc. at 1-800-673-1558, web site WWW.ECHO-USA.COM or contact Shindaiwa at 1-877-986-7783, web site WWW.SHINDAIWA.COM.

WHAT DOES THIS WARRANTY COVER?

ECHO Inc. warrants that your equipment/SORE was designed, built and equipped to conform with applicable EPA and C.A.R.B. emissions standards and that your equipment/SORE is free from defects in material and workmanship that would cause it to fail to conform with applicable requirements for 2 years or the length of the ECHO Inc. warranty, whichever is longer. The warranty period begins on the date the product is purchased by an end user.

HOW WILL A COVERED PART BE CORRECTED?

If there is a defect in a part covered by this warranty, any ECHO Inc. Authorized Service Dealer will correct the defect. You will not have to pay anything to have the part adjusted, repaired or replaced. This includes any labor and diagnosis for warranted repairs performed by the dealer. In addition, engine parts not expressly covered under this warranty but whose failure is a result of a failure of a covered part will be warranted.

WHAT PARTS ARE COVERED?

Any applicable emission related part not scheduled for "required maintenance" will be repaired or replaced within the warranty period. The repaired or replaced part will be warranted for the remaining ECHO Inc. warranty period.

Any warranted part that is scheduled only for regular inspection in the written instructions supplied is warranted for the warranty period stated above. Any such part repaired or replaced under warranty will be warranted for the remaining ECHO Inc. warranty period.

Any emission related part scheduled for replacement during "required maintenance" is warranted for the period of time prior to the first scheduled replacement point for that part. Any such part repaired or replaced under warranty shall be warranted for the remainder of the period prior to the first scheduled replacement point for that part.

Any manufacturer-approved replacement part may be used in the performance of any warranty maintenance or repairs on emission related parts, and must be provided without charge if the part is still under warranty.

Any replacement part that is equivalent in performance and durability may be used in non-warranty maintenance or repairs, and shall not reduce the warranty obligations of the manufacturer.

Throughout the equipment/SORE warranty period, ECHO Inc. will maintain a supply of warranted parts sufficient to meet the expected demand for such parts.

SPECIFIC EMISSION RELATED WARRANTED PARTS:

- Electronic Ignition System
- Catalytic Converter / Muffler Assembly
- Choke
- Fuel Tank
- Air Filter
- Spark Plug
- Carburetor (complete assembly or replaceable components)
- Fuel-Injection Assembly (or replaceable components)
- Fuel Cap Assembly
- Fuel Feed Line (and associated clamps/connectors as applicable)

WHAT IS NOT COVERED?

Any failure caused by abuse, neglect, improper maintenance, unapproved modifications, use of unapproved add-on parts/modified parts or unapproved accessories.

This Emission Control Warranty is valid only for the U.S.A., it's Territories, and Canada.

**99922201033
01/2010**

Servicing Information

Parts/Serial Number

Genuine Shindaiwa Parts and Assemblies for your Shindaiwa products are available only from an Authorized Shindaiwa Dealer. When you do need to buy parts **always** have the Model Number and Serial Number of the unit with you. You can find these numbers on the engine. For future reference, write them in the space provided below.

Model No. _____ _SN. _____

Service

Service of this product during the warranty period must be performed by an Authorized Shindaiwa Service Dealer. For the name and address of the Authorized Shindaiwa Service Dealer nearest you, ask your retailer or call: 1-877-986-7783. Dealer information is also available on WWW.SHINDAIWA.COM. When presenting your unit for Warranty service/repairs, proof of purchase is required.

Consumer Product Support

If you require assistance or have questions concerning the application, operation or maintenance of this product you may call the Shindaiwa Consumer Product Support Department at 1-877-986-7783 from 8:30 am to 4:30 pm (Central Standard Time) Monday through Friday. Before calling, please know the model and serial number of your unit.

Warranty Registration

To ensure trouble free warranty coverage it is important that you register your Shindaiwa equipment by filling out the warranty registration card supplied with your unit. Registering your product confirms your warranty coverage and provides a direct link if we find it necessary to contact you.

Additional or Replacement Manuals

Replacement Operator and Parts Catalogs are available from your Shindaiwa dealer or at WWW.SHINDAIWA.COM or by contacting the Consumer Product Support Department (1-877-986-7783). Always check WWW.SHINDAIWA.COM for updated information.

shindaiwa[®]

ECHO Incorporated.
400 Oakwood Road
Lake Zurich, IL 60047-1564 U.S.A.
Telephone: 1-877-986-7783
Fax: 1-847-540-8416
www.shindaiwa.com

Yamabiko Corporation
7-2 Suehirocho 1-Chome, Ohme,
Tokyo, 198-8760, Japan
Phone: 81-428-32-6118
Fax: 81-428-32-6145